

Profile SE

1700 x 750

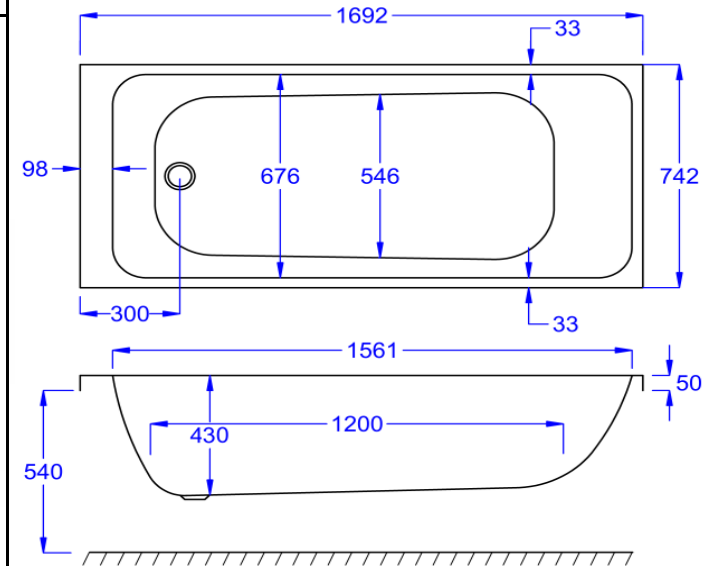

Technical Information



Water Capacity

257 litres

Installation Kit

Standard - AK-01

Carronite - AK-01-C

Whirlpool Compatibility

N/A

Bath Codes

Profile 1700x700 Standard 02424
 Profile 1700x700 Carronite 02425

Screen Codes

CFS1 Curved Profile 02344
 CFS1 Square Profile 02346

Panel Codes

L-Shape 1700x750x540 Panel 02300
 Front 1700x540 Standard Panel 02318
 Front 1700x540 Carronite Panel 02319
 End 750x540 Standard Panel 02289
 End 750x540 Carronite Panel 02275

Carron Bathrooms Limited

North Carron Works
 Stenhouse Road
 Falkirk, FK2 8UW

Email : info@carronbathrooms.com
 Web : www.carronbathrooms.com
 Tel : +44 (0)1324 638 407

