

Profile DE

1650 x 700

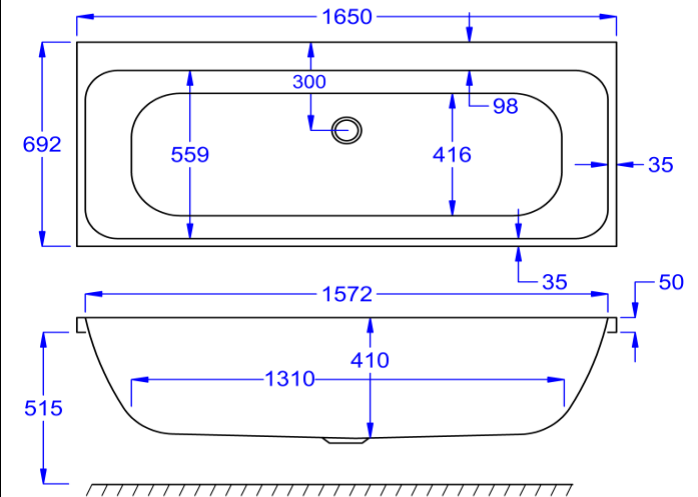

Technical Information



Water Capacity

196 litres

Installation Kit

Standard - AK-01

Carronite - AK-01-C

Whirlpool Compatibility

N/A

Bath Codes

Profile DE 1650x700 Standard 02521
Profile DE 1650x700 Carronite 02522

Screen Codes

CFS1 Curved Profile 02344
CFS1 Square Profile 02346

Panel Codes

L-Shape 1650x700x515 Panel 02531
Front 1650x515 Standard Panel 02282
Front 1650x515 Carronite Panel 02268
End 700x515 Standard Panel 02285
End 700x515 Carronite Panel 02271

Carron Bathrooms Limited

North Carron Works
Stenhouse Road
Falkirk, FK2 8UW

Email : info@carronbathrooms.com
Web : www.carronbathrooms.com
Tel : +44 (0)1324 638 407

THE NAME FOR BATHS